

ELECTRICAL PROPERTIES

Critical Impulse Flashover Voltage		
Positive	kV	170
Impulse Withstand Voltage	kV	150
Wet p.f. Withstand Voltage	kV	60

PHYSICAL PROPERTIES

Nominal Creepage Distance	In.	24.38
Net Weight	lb.	12.5
Color		Light Grey

MECHANICAL PROPERTIES

Cantilever Strength, Upright	lb.	800
Cantilever Strength, Underhung	lb.	800
Torsion Strength	in. - lb.	5000
Tension Strength	lb.	5000
Reference Standard		ANSI C29.9

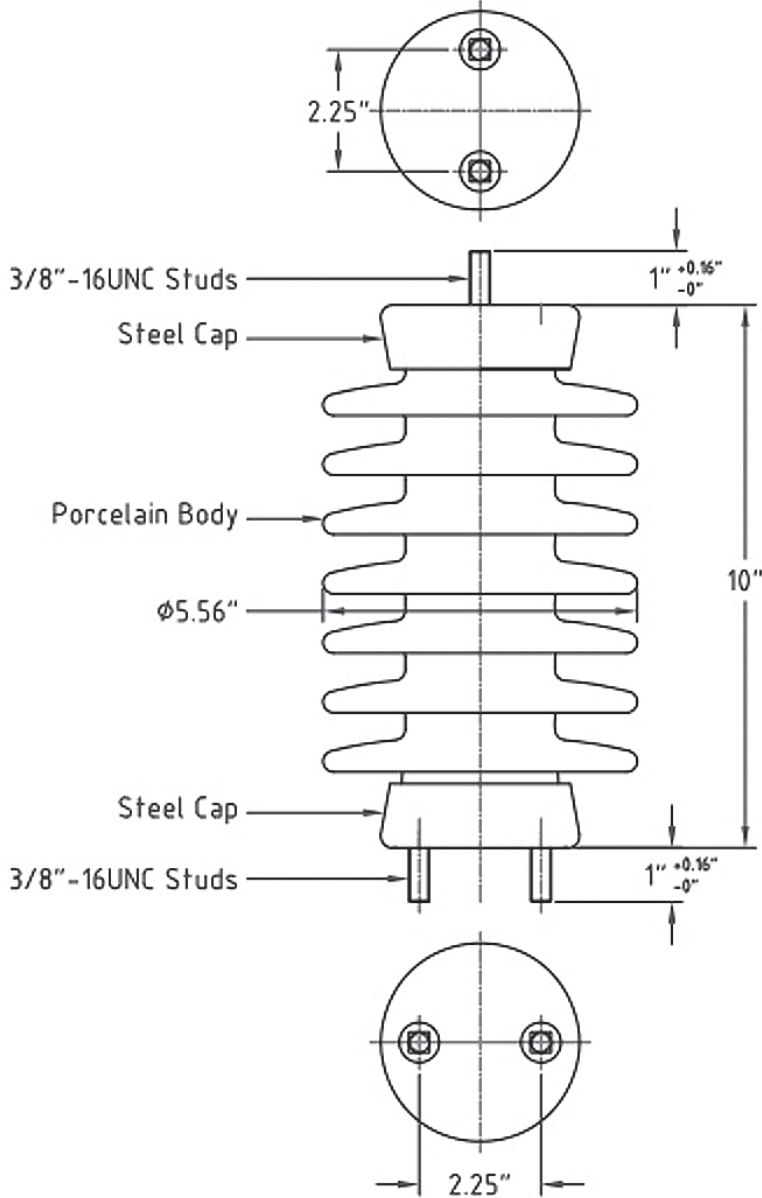

NOTES:

1. All ferrous parts Hot Dip Galvanized.
2. Exposed cement surface coated with silicone.



Meister International, LLC

P.O.Box 338 Ross, Ohio 45061 USA

Tel: 513-923-2712 • Fax: 513-923-1978 • Email: sales@meisterintl.com

www.meisterintl.com

PART NO. 6034AX
PORCELAIN SWITCH POST INSULATOR
23kV, 150kV BIL